

Advertise with AliMed[®]

Reach thousands of medical professionals in our
2023-2024 Pediatrics & Neonatal Catalog!



Target Audience

Children's Hospitals,
Hospitals with Pediatric Services,
ASCs with Pediatric Services,
Military Hospitals

Circulation

14.5K

Page Count

246

2023-2024

Delivery Dates

9/12/2023, 1/30/2024

Ad Commitment

Deadline

3/13/2023

Now available

Discounts for multiple ad placements, see Order Form on p. 3 for details.

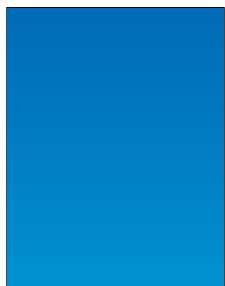

A. Full Page w/bleed

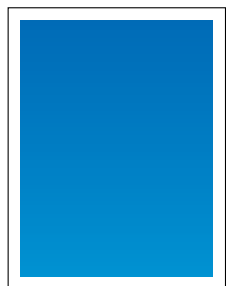

B. Full Page

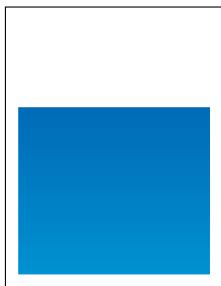

C. 2/3 Page

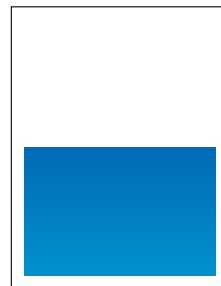

D. 1/2 Page

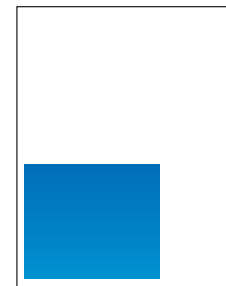

E. 1/3 Page Square

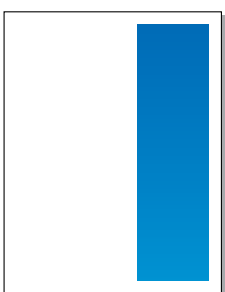

F. 1/3 Page Vertical

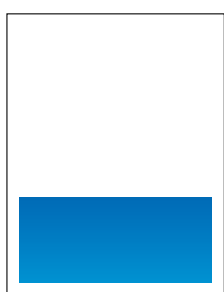

G. 1/3 Page Horizontal

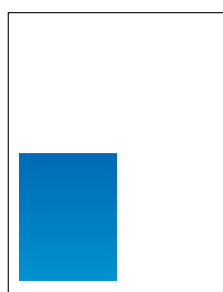

H. 1/4 Page Square

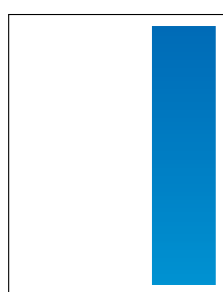

I. 1/4 Page Vertical

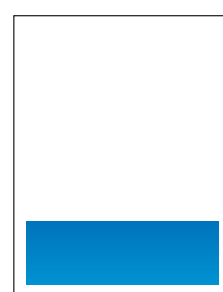

J. 1/4 Page Horizontal

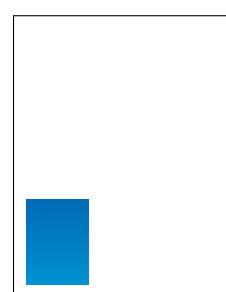

K. Single Column

Catalog Ad	Size	Price
A. Full Page w/bleed*	8.75"W x 11"H	\$3,968
B. Full Page	7.4"W x 9.7"H	\$3,968
C. 2/3 Page	4.8"W x 9.1"H	\$3,621
D. 1/2 Page	7.4"W x 4.5"H	\$2,948
E. 1/3 Page Square	4.9"W x 4.5"H	\$1,958
F. 1/3 Page Vertical	2.35"W x 9.1"H	\$1,958
G. 1/3 Page Horizontal	7.4"W x 3"H	\$1,958

Index Ad	Size	Price
A. Full Page w/bleed*	8.75"W x 11"H	\$2,980
B. Full Page	7.4"W x 9.7"H	\$2,980
D. 1/2 Page	7.4"W x 4.5"H	\$2,150
E. 1/3 Page Square	4.9"W x 4.9"H	\$1,900
F. 1/3 Page Vertical	2.361"W x 9.78"H	\$1,900
G. 1/3 Page Horizontal	7.417"W x 3.26"H	\$1,900
H. 1/4 Page Square	3.5"W x 4.9"H	\$1,650
I. 1/4 Page Vertical	1.75"W x 9.7"H	\$1,650
J. 1/4 Page Horizontal	7.4"W x 2.5"H	\$1,650
K. Single Column	2.35"W x 3"H	\$995

Ad requirements:

- The company name/logo should appear within the artwork.
- Manufacturer's phone number, fax number, email, or web address must not appear on ad.
- For web address, please use AliMed.com (note: no "www." and "A" and "M" are capitalized).
- For phone number, please use 800.225.2610 (stylized with periods instead of dashes).
- AliMed can supply artwork for an additional charge. Note this request at time of purchase.

*For ads that bleed:

Trim size is 8³/₈"W x 10¹/₂"H; bleed allowances are no less than 1/8" outside of crops.

Ad image must extend a minimum of 1/8" past trim size.

Please keep all text in ad a minimum of 1/2" away from trim edge.

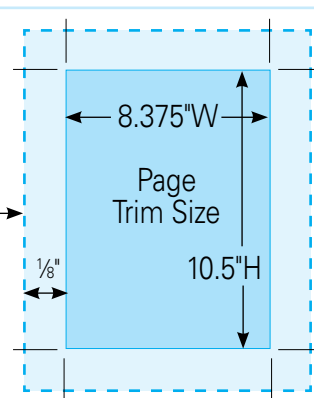

All ads must be four-color, hi-resolution (300 dpi) PDF suitable for print.

Please send finalized ad PDF to ads@AliMed.com.

Order Form

	Delivery Date	Commitment Date	Art Due	Index Art Due	Number of Catalog Ads:						Number of Index Ads:						Ext. Price			
					Full Page	3/4 Page	1/2 Page	1/3 p. Square	1/3 p. Vertical	1/3 p. Horizontal	Full Page	1/2 Page	1/3 p. Square	1/3 p. Vertical	1/3 p. Horizontal	1/4 p. Square		1/4 p. Vertical	1/4 p. Horizontal	Single Column
2023-2024	9/12/23	3/13/23	5/11/23	6/15/23																
Pediatrics & Neonatal																				

Product(s) featured are subject to the discretion of the AliMed Product Manager.

Current Catalog Pricing Schedule: **SAME LOW PRICE GUARANTEED!**

Size	Selling Pages	Index Pages	Total:
Full Page	\$3,968.00	\$2,980.00	_____
3/4 Page	\$3,621.00	—	Multi Ad Discount: _____
1/2 Page	\$2,948.00	\$2,150.00	Order Total: _____
1/3 Page	\$1,958.00	\$1,900.00	Design Fee***: _____
1/4 Page	—	\$1,650.00	
Single Column	—	\$995.00	

Multiple Ad Placement Discount**

2-5 Ads SAVE 5%

6-9 Ads SAVE 10%

10+ Ads SAVE 20%

**Applies to total ad placements on this order only.

Advertiser Information:

Payment Preference: Direct Billing _____ (Invoice mailed after publication delivers)
PLEASE NOTE: Ad space will be billed after the publication delivery date.
 A copy of the publication is mailed with the invoice to the person listed below.

Merchandise Credit* _____ (Amount will be deducted on AliMed's next payment)
 *Price approval is required for merchandise credit payments.

AUTHORIZED SIGNATURE: _____ PRINT NAME: _____ DATE: _____

Name of Company: _____

Address: _____ City: _____ State: _____ Zip: _____

Telephone: _____ Fax: _____ Email: _____

Questions should be directed to ads@AliMed.com. Please scan and send completed order form via email to ads@AliMed.com or fax to: 781.493.6523. ***Applies only to AliMed-designed ads.

Terms and Conditions

Warranties: EXCEPT FOR THE LIMITED WARRANTY THAT THE PRINTING PRODUCT PURSUANT TO THIS CONTRACT SHALL BE COMMERCIALY ACCEPTABLE, THERE ARE NO IMPLIED WARRANTIES OF MERCHANTABILITY OR IMPLIED WARRANTIES OF FITNESS WHICH ATTACH TO THIS CONTRACT OR PERFORMANCE HEREUNDER. ALIMED® SHALL NOT BE HELD LIABLE FOR INDIRECT OR CONSEQUENTIAL LOSS OF PROFITS OR OTHER SPECIAL, INDIRECT, OR CONSEQUENTIAL DAMAGES.

Copyright: Vendor hereby indemnifies and saves AliMed harmless in all respects whatsoever for any claims, causes of actions, suits, or the like arising from, or in connection with, the printing of AliMed's publications. Such indemnification shall include, but is not limited to, any and all attorney's fees incurred by AliMed in defending itself and any and all judgments, fines, court costs, and settlement costs.

Printer reserves the right to refuse to print or reproduce any material supplied by Vendor if AliMed is of the opinion that reproduction of such materials would subject AliMed to a claim of copyright infringement. AliMed shall not be liable for the payment of any damages incurred by Vendor in the event of any such refusal to print.

Taxes: Federal excise taxes and any state, county, municipal, or other government taxes which are applied to this order shall be charged as an addition to the price quoted to Vendor. Vendor agrees to pay any such charges promptly upon demand.

Miscellaneous Provisions: Material supplied to AliMed by Vendor shall remain the property of the customer. However, AliMed may retain possession thereof without any liability until all bills due and payable to the Vendor under agreement have been paid.

Artwork, type, plates, negatives, positives, and other items, when supplied by Vendor, shall remain the sole and exclusive property of AliMed unless otherwise agreed in writing.

Terms: All invoices are due and payable as stated on the invoice. Invoices not paid according to these terms shall bear interest at the rate of 1.5% per month on the net, unpaid invoice amount.

AliMed shall not be responsible for delay or failure to perform caused by strikes; failure of supply of paper or other materials; government rules, orders, laws, or regulations; destruction of the printing plants; floods; fire; delays of carriers; acts of God; or similar occurrences beyond the reasonable control of AliMed.

This agreement constitutes the entire agreement of the parties with respect to the subject matter hereof, and the provisions herein shall supersede any and all prior agreements or understandings between the parties, without respect to subject matter. This agreement may not be amended or modified except by writing signed by both parties hereto and approved by an officer of AliMed.

This contract shall be construed according to and governed by the laws of the Commonwealth of Massachusetts.

In the event of any controversy or dispute between the parties, including without limitation Publisher's failure to pay any sums due in a timely manner, the parties hereto agree to confer exclusive jurisdiction over the parties and venue unto the Circuit Court of Norfolk County, Massachusetts. Each party here to appoints the Secretary of the Commonwealth of Massachusetts as his duly authorized agent for receipt and acceptance of service of process. If AliMed is required to file suit due to Vendor failure to make any payments when due, then, in addition to any other remedy allowed by law, AliMed shall be entitled to recover reasonable attorney's fees and costs.

Signature _____ Date _____